

Rollair

Rotary Screw Compressors

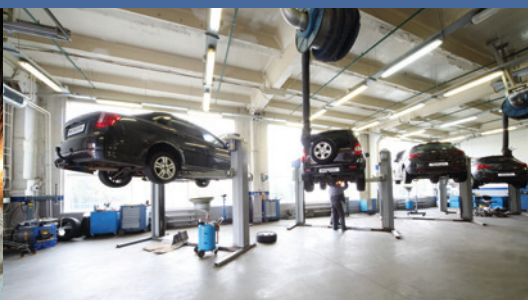
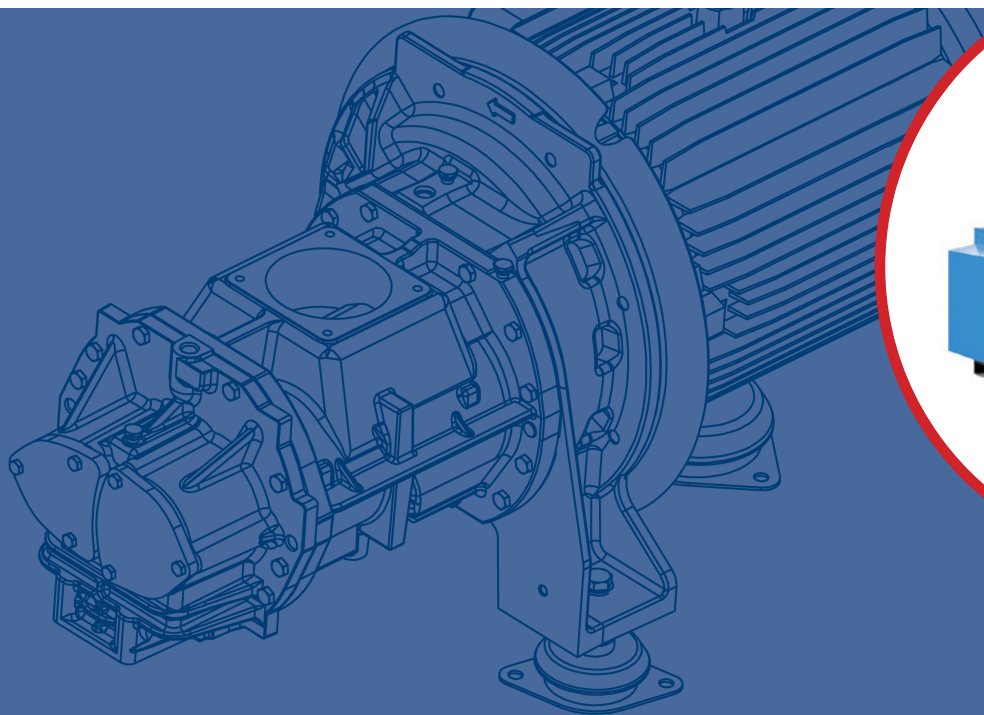

ROLLAIR 20-34 (V)

Worthington Creyssensac's heritage

Creysensac was founded in Nanterre (near Paris), France in 1934 by Elie Creysensac and quickly became renowned in the automotive industry for developing high quality piston compressors.

In the mid nineteen sixties, screw compressors were added to the product portfolio while 1973 saw the merge with Worthington. This further expanded the influence of the company in the compressed air world and reinforced the distributor network.

Today, its long-standing experience and continuous innovation ensure Worthington Creyssensac is a trusted partner for its customers.



Driven by technology Designed by experience

Discover what happens when a passion for technology is fused with hands-on industrial experience. Designs evolve towards more practical installation and maintenance, giving you the freedom to focus on your job. Product ranges include the exact machine you need, with the right options for your performance needs. Return on investment is ensured, while your carbon footprint shrinks. And, because we stay close to our customers, we're one step ahead when your needs change.

**INNOVATION
HANDS-ON
EXPERIENCE
PEACE OF MIND
TOTAL COST
OF OWNERSHIP
PARTNERSHIP**

The range that meets all your requirements

With the Rollair range you obtain an efficient, reliable and complete solution which fits a wide range of compressed air requirements.

A wide offer for you

- Available power sizes from 20 up to 35 hp.
- One pressure variant (5,5-12,5 bar) for Rollair 20-34 V.

High efficiency transmissions

- Reduced energy consumption compared to belt driven technology.
- Low noise levels: the Rollair can be installed close to the workplace.
- Longer service intervals compared to belt technology.

Easy accessibility and installation

- Easy to service thanks to the large hinged doors and removable panels.
- Easy to install thanks to a high variety of configurations and scope of supply.

The options you need

- Graphic and integrated central controller.
- Energy recovery.
- 8000h oil.
- Connectivity - ICONS box.
- Canopy heater.
- Food grade oil.
- Compressed air filter to improve the air quality.
- WSD to protect your dryer from moisture.
- ...and much more to customize your machine!



www.airwco.com

The right fit for each customer

Check out these innovative features of the Rollair 20-34 range and see how they provide you with a complete offer: high efficiency, easy maintenance and a low noise level.

High quality drive train (gear and direct transmission)

- Gearbox technology for great energy efficiency and reliability installed on the Rollair 20-34 units.
- No long-term loss thanks to the combination of screw rotors and gearbox technology.
- Direct driven transmission (1) for outstanding energy efficiency and reliability installed on the Rollair 20-34V units.
- In-house designed element with high performance (specific energy requirements and FAD) (2).
- Standard IP 55 class F IE3 motor for Rollair 20-34 (3).
- High frequency converter duty motor for Rollair 20-34 V (4).
- Primary suppliers for main outsourced components like motors and converters (5), with world wide support.

Highly efficient air intake filtration and oil separation

- Fresh air taken from the cold side of the compressor to improve efficiency.
- Two micron encapsulated intake filters guarantee only clean air enters the compressor (6).
- Spin on oil separation (7) with oversized oil vessel (8) for a pressure drop < 250 mbar.

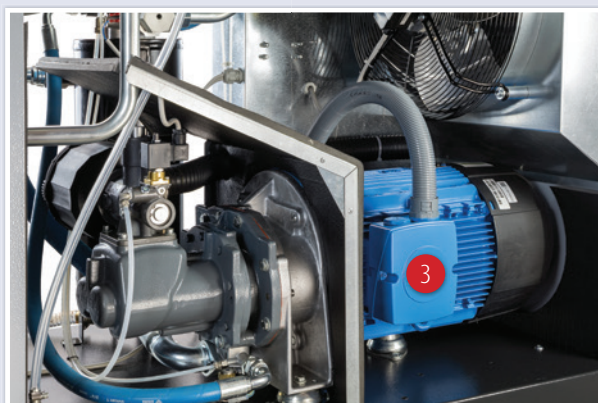

Optimal ventilation and oversized cooler

- Improved cooling flow results in a lower working temperature.
- A separated air flow offers you an efficient motor and inverter cooling together with a long life time of oil, components and compressor (9).
- Optimal ventilation flow is assured with low energy consumption.
- Oversized oil and air cooler for better cooling and lower operating temperature (10).

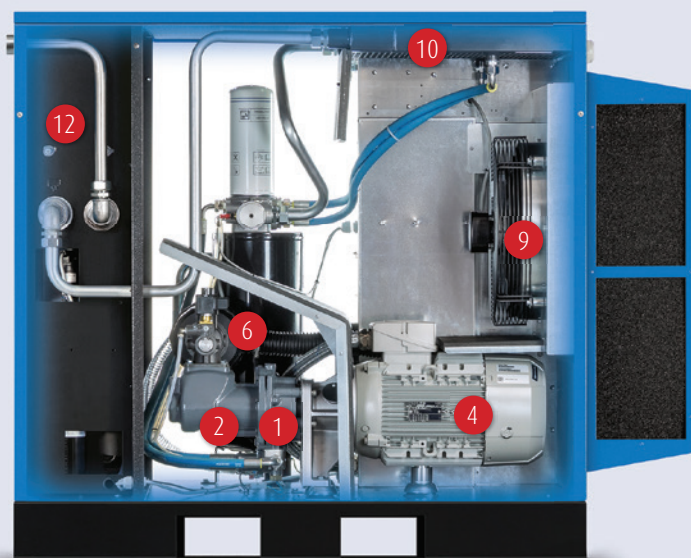

Integrated inverter

- Easy accessible integrated inverter drive (5).
- Optimal FAD range control.
- New cubicle cooling system to improve electrical device reliability.

Quiet operation

Thanks to the improved noise insulation, the compressor works very quietly and can be placed near the workplace.

Air quality

- Internal water separator (11) with automatic drain removes up to 90% of compressed air moisture (standard with dryers).
- Oversized dryer (12) installed in the cold part of the unit to ensure the maximum of moisture removal.



How to optimize your energy consumption

Energy costs represent about **70%** of the total operating cost of your compressor over a 5-year period. That is why reducing the operating cost of a compressed air solution is a major focus.

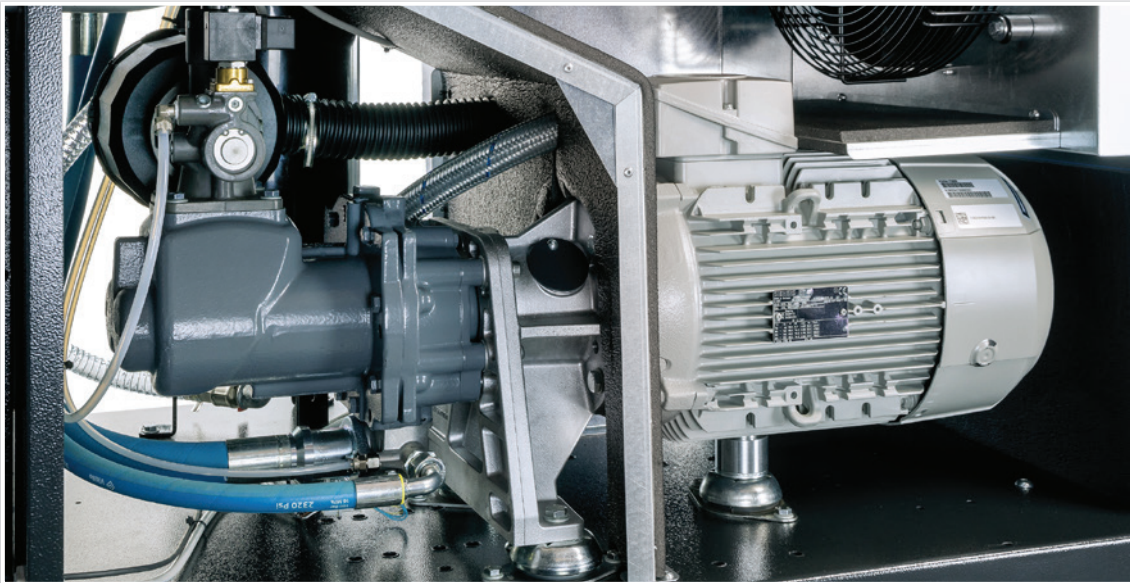

Variable speed technology

For the right application, variable speed technology, can cut the energy bill of your compressor by up to **30%**.

- The variable frequency drive compressor matches air supply with demand therefore reducing energy consumption when the demand is lower. If the demand is stable then the controller guarantees a fixed set pressure.
- No unload cycles above 20% load.
- No peak current due to soft start.
- Improved efficiency thanks to the new direct driven transmission

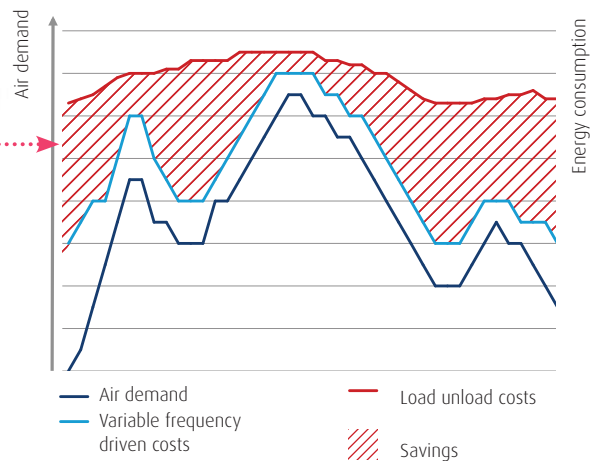
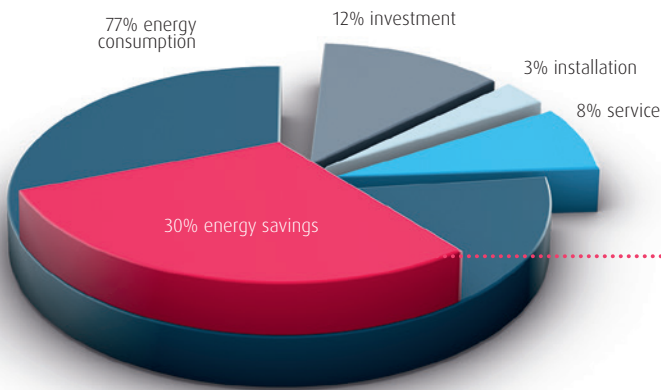

Always in control with Infologic² and Airlogic²



Infologic² (standard on Rollair)

- Icon based display action
- Led status visualization.
- Digital I/O.
- Remote start stop, load-unload, emergency stop.
- Automatic restart after a power failure.
- Service indicator and fault management provide comprehensive messages to ease service diagnostics.
- Visualization through web browser using a simple Ethernet connection.



Airlogic² (standard on Rollair V, optional on Rollair)

The Airlogic² takes your control to the next level, offering additional functionalities:

- User-friendly graphic screens, data logging and storage on a memory card.
- Stop/start timers do not rely on the operator's action to save energy, but program the Airlogic² controller to operate as your factory operates.
- Dual pressure band time scheduling for operation with different pressure bands, leading to energy savings.

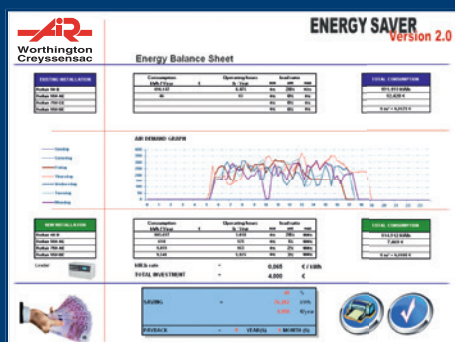

Energy audit

Knowing what compressor is right for your application is critical to minimizing the energy consumption. With our Energy Audit we can simulate your compressed air needs and then consult you on the best solution for your needs.

For more information, please contact your local Worthington Creyssensac representative.

Improve your energy recovery

When air is compressed, heat is formed. The excess heat can be captured with an energy recovery option and channeled to other applications allowing you to save energy and cut costs.

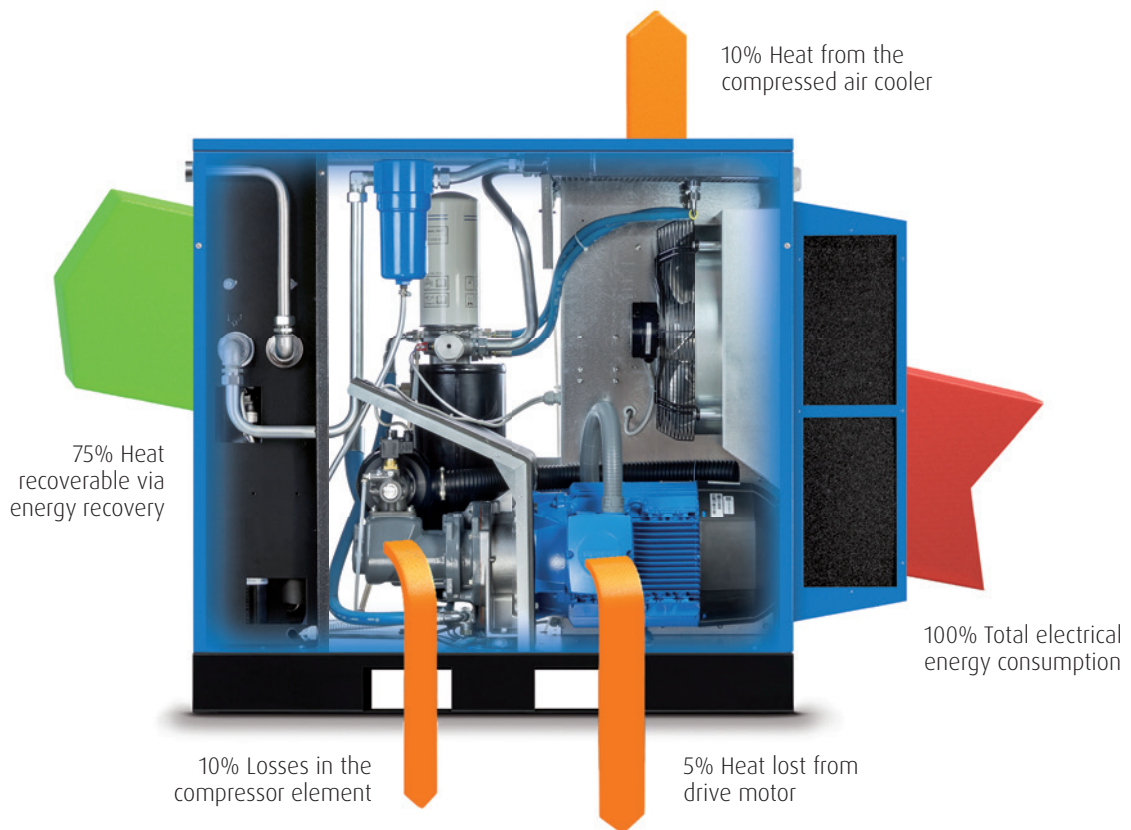

Water cooling recovery

In the energy recovery units (optional) the oil circuit is pre-cooled with an oil/water heat exchanger. Water then becomes the fluid transport media to recover the oil temperature. The hot water resulting from this process can be used to heat radiators or water boilers, pre-heat supply water or hot tap water, and other industrial applications.

The energy recovery option integrates a heat exchanger on the oil circuit, which heats up the continuously pressurized water flow. The system is regulated automatically, and in case of limited water cooling capacity, the standard cooling system of the compressor will operate and backup the energy recovery device.

The energy recovery option is a simple mechanical system that requires no maintenance or electricity consumption, but offers you significant reductions in your energy costs.



Options to optimize your operations

A wide range of options enables you to get the most out of your Rollair 20-34 (V).



Air quality

- **Internal water separator with floating drain** reduces up to 90% of the compressed air moisture. Standard on T units.
- **Line filter** for oil and dust removal down to 0.1 ppm for plus versions.
- **Heavy duty air intake filtration** prevents dust entering the pneumatic circuit in very dusty environments.
- **Canopy heater** for low temperature installation.
- **Electronic zero loss drain** for water separator to easily drain the condensate without any compressed air loss.
- **Food grade oil** for food & beverage applications



Efficiency

- **Energy recovery pack** to recover up to 70% of the electrical energy consumption as warm water for showers, boilers etc.
- **8000h oil**

Control & monitoring

- **Airlogic² Graphic Control** (standard on Rollair V - optional on Rollair).
- **ECOnTrol6i** integrated multiple compressor control for 4/6 compressors (with Airlogic² only).
- **Remote monitoring** for additional convenience.

For further information on how our options can optimize your operations, please contact your local representative.

Technical specifications Rollair 20-34

Fixed Speed

Model	Max. working pressure ***	Free Air Delivery @ reference conditions *				Motor power		Noise level **	Weight		
		bar	m ³ /h	l/s	l/min	cfm	kW		hp	FM	FM D
								dB(A)	kg		
RLR 20	7,5	165	45,9	2751	97	15	20	66	345	400	575
	8,5	155	43,1	2588	91						
	10	137	38,2	2289	81						
	13	119	33,1	1986	70						
RLR 25	7,5	202	56,2	3372	119	18,5	25	67	370	430	605
	8,5	192	53,3	3198	113						
	10	176	49,0	2940	104						
	13	140	38,8	2326	82						
RLR 29	7,5	234	64,9	3897	138	22	30	68	385	445	620
	8,5	226	62,7	3760	133						
	10	198	55,0	3301	117						
	13	168	46,6	2796	99						
RLR 34	7,5	258	71,6	4296	152	26	35	70	400	460	635
	8,5	244	67,8	4068	144						
	10	228	63,4	3804	134						
	13	200	55,5	3330	118						

* Unit performance measured according to ISO 1217, Annex C, latest edition

** Noise level measured according to ISO 2151:2004 using ISO 9614/2

*** Reference working pressure: 7 - 8 - 9,5 - 12,5 bar



Technical specifications Rollair 20-34 V

Variable Speed

Model	Min. working pressure Bar/psi	Max. working pressure Bar/psi	Min. FAD*															Motor power		Noise level dB(A)	Weight		
			7 Bar			7 Bar			8,5 Bar			9,5 Bar			12,5 Bar						FM	FM D	500L D
			m³/h	l/s	l/min	m³/h	l/s	l/min	m³/h	l/s	l/min	m³/h	l/s	l/min	m³/h	l/s	l/min	kW	hp	kg	kg	kg	
RLR 20 V	5,5 / 80	13 / 189	47	13	780	178	49,5	2969	160	44,5	2672	152	42,3	2539	131	36,4	2182	15	20	67	325	380	555
RLR 25 V	5,5 / 80	13 / 189	47	13	780	215	59,6	3575	197	54,8	3291	185	51,5	3091	149	41,4	2485	18,5	25	68	340	400	575
RLR 29 V	5,5 / 80	13 / 189	47	13	780	240	66,7	4000	221	61,3	3678	207	57,6	3454	185	51,5	3091	22	30	69	345	410	585
RLR 34 V	5,5 / 80	13 / 189	47	13	780	255	70,7	4242	238	66,2	3969	229	63,6	3818	200	55,5	3333	26	35	70	365	425	600

* Unit performance measured according to ISO 1217, Annex C, latest edition

** Noise level measured according to ISO 2151:2004 using ISO 9614/2

Dimensions Fixed Speed & Variable Speed

Model fixed + variable speed	Length	Width	Height
	mm		
Floor mounted	1395	835	1220
Floor mounted + dryer	1545	835	1220
500L + dryer	1940	835	1835





**Worthington
Creysensac**

DRIVEN BY TECHNOLOGY DESIGNED BY EXPERIENCE



**CONTACT YOUR LOCAL
WORTHINGTON CREYSENSAC
REPRESENTATIVE**

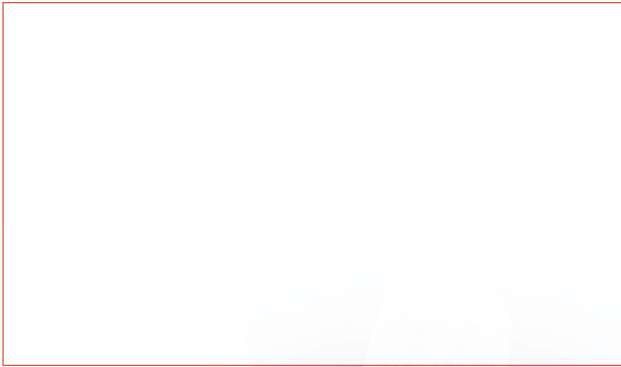

Care. Trust. Efficiency.

Care.

Care is what service is all about: professional service by knowledgeable people, using high-quality original parts.

Trust.

Trust is earned by delivering on our promises of reliable, uninterrupted performance and long equipment lifetime.

Efficiency.

Equipment efficiency is ensured by regular maintenance. Efficiency of the service organization is how Original Parts and Service make the difference.

